



What we learned from the silicon absorption measurement at LMA

J. Degallaix, D. Forest C. Carcy, L. Pinard and R. Flaminio

Outline



- The mirage effect and how to measure absorption
- Measurement and theory at room temperature
- Some remarks for E.T.

The photodeflection technique



High power laser beam incident on the sample

absorption

Gradient of temperature

thermorefractive coefficient

Gradient of refractive index

eikonal equation

Deviation of the light

The photodeflection technique



The photodeflection technique

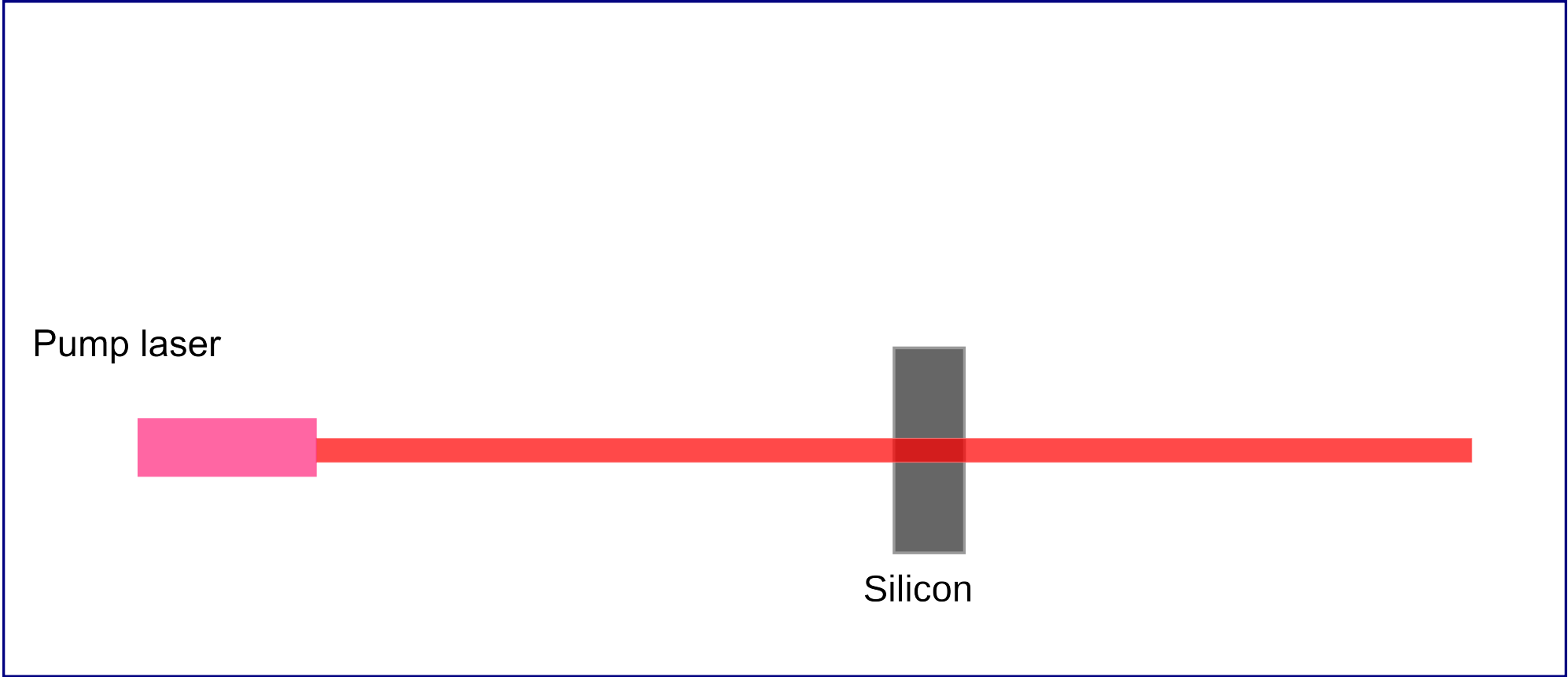

The photodeflection technique

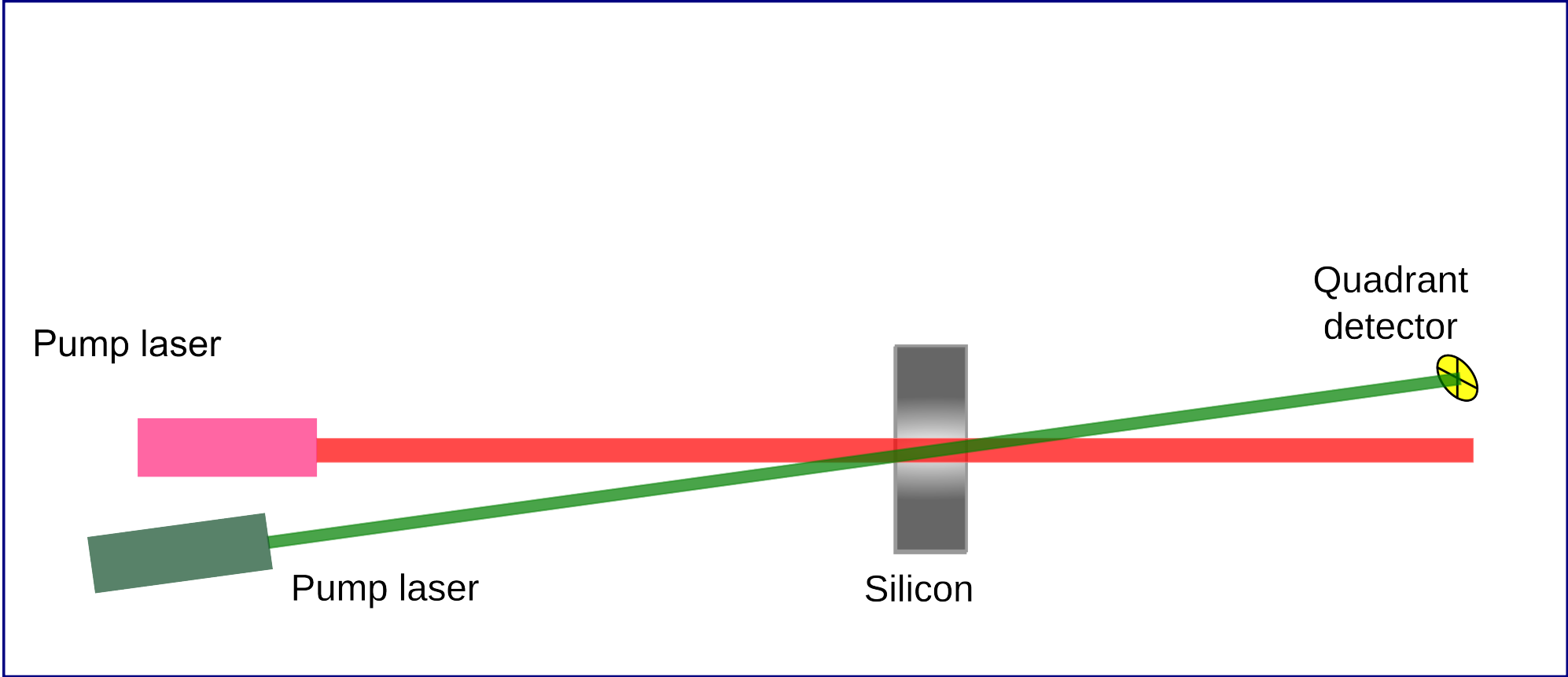

The photodeflection technique

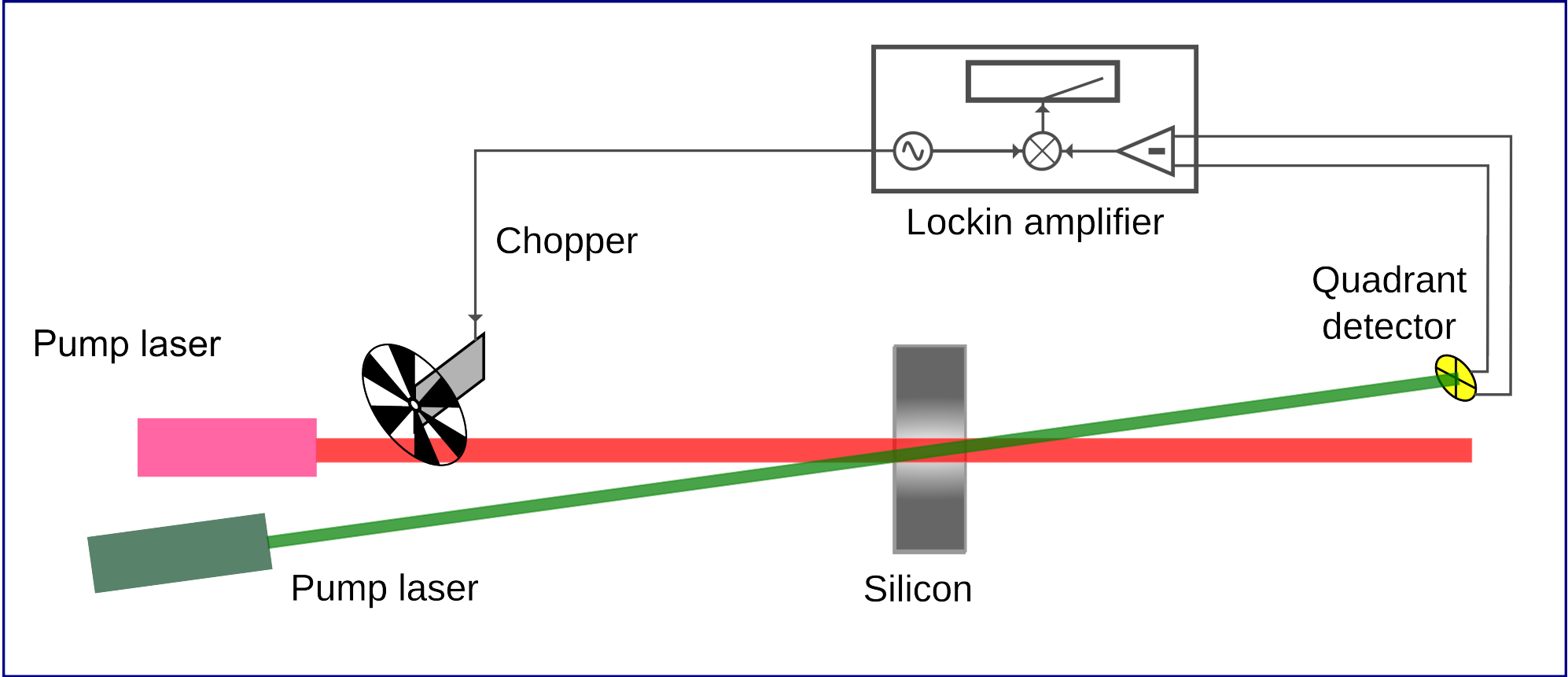

The photodeflection technique

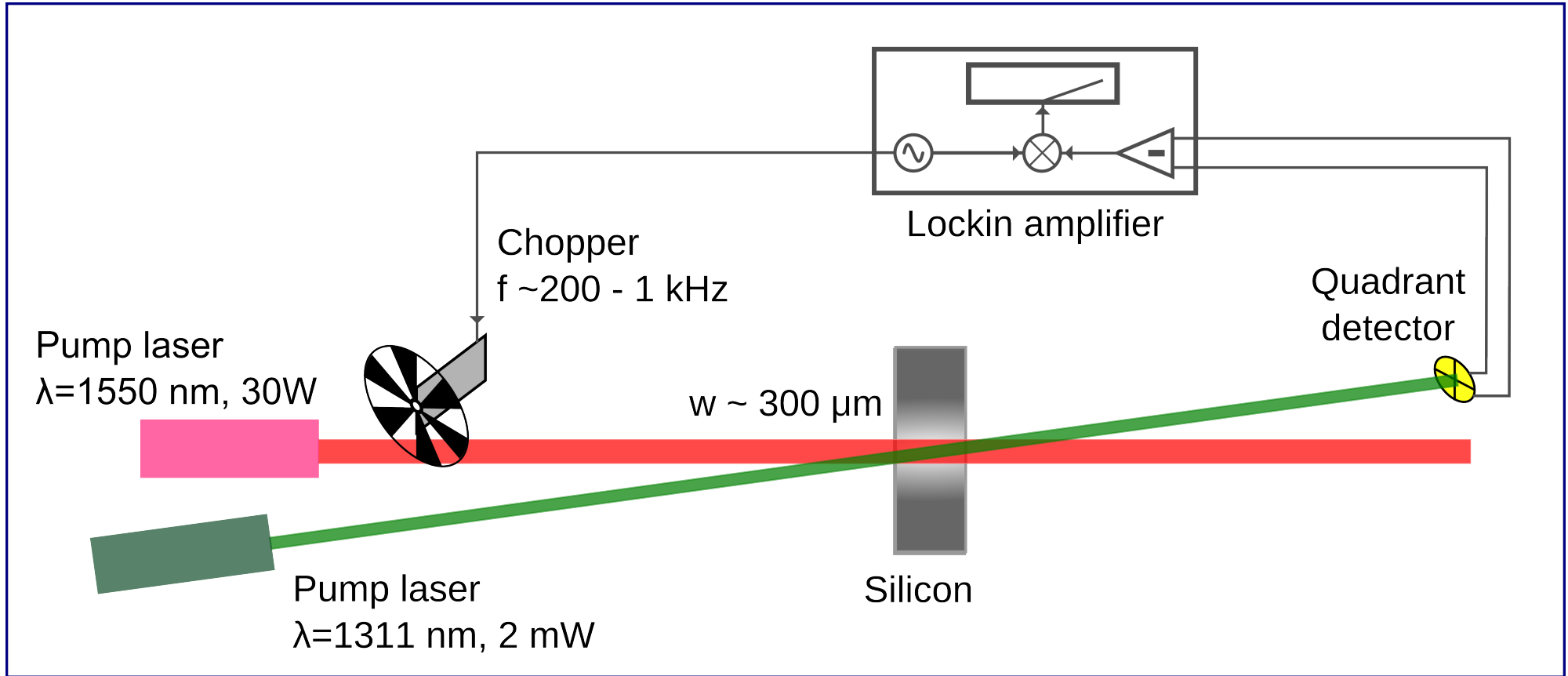

Why this technique ?

Long experience of this technique at LMA:

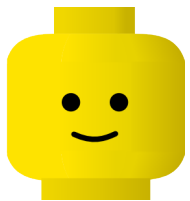
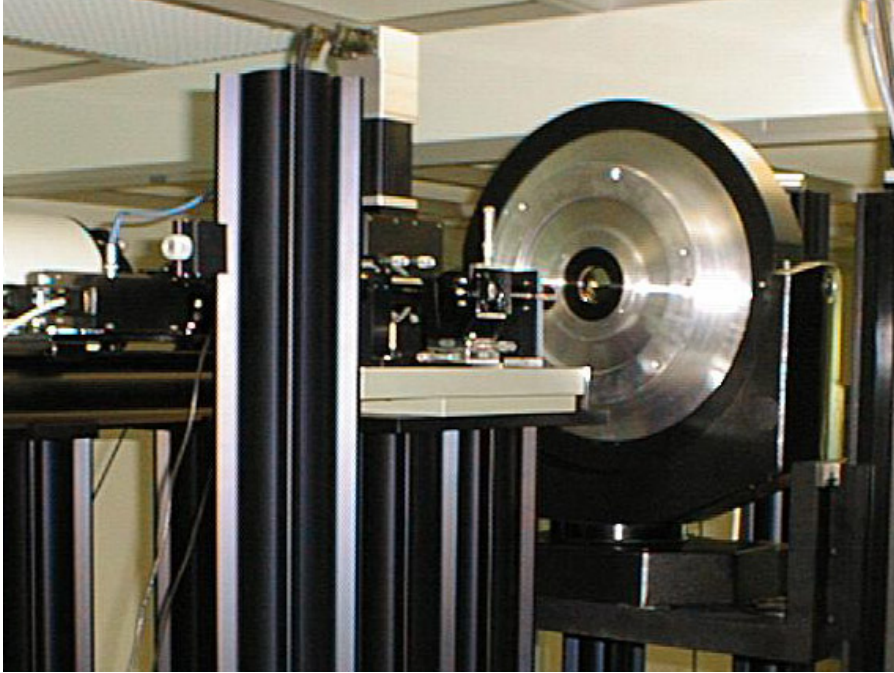

- Excellent sensibility (down to 0.3 ppm on silica)
- Measure surface absorption or volume absorption
- Can derive 3D maps

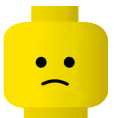

- Required a reference in absorption

Example of measurement

On an absorption reference made of fused silica:

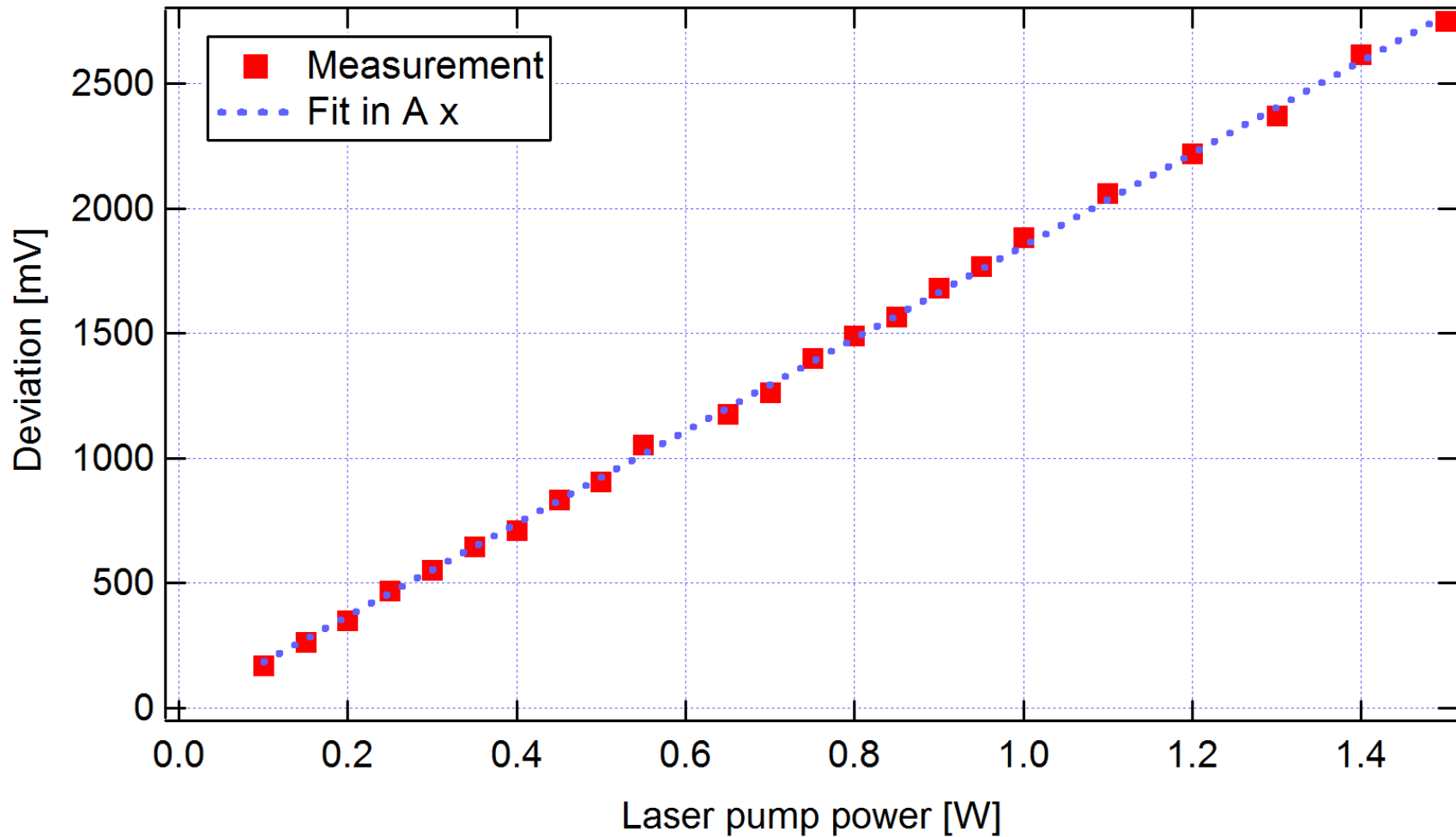

(a straight line means the absorption is constant)

Example of measurement

On a silicon sample:

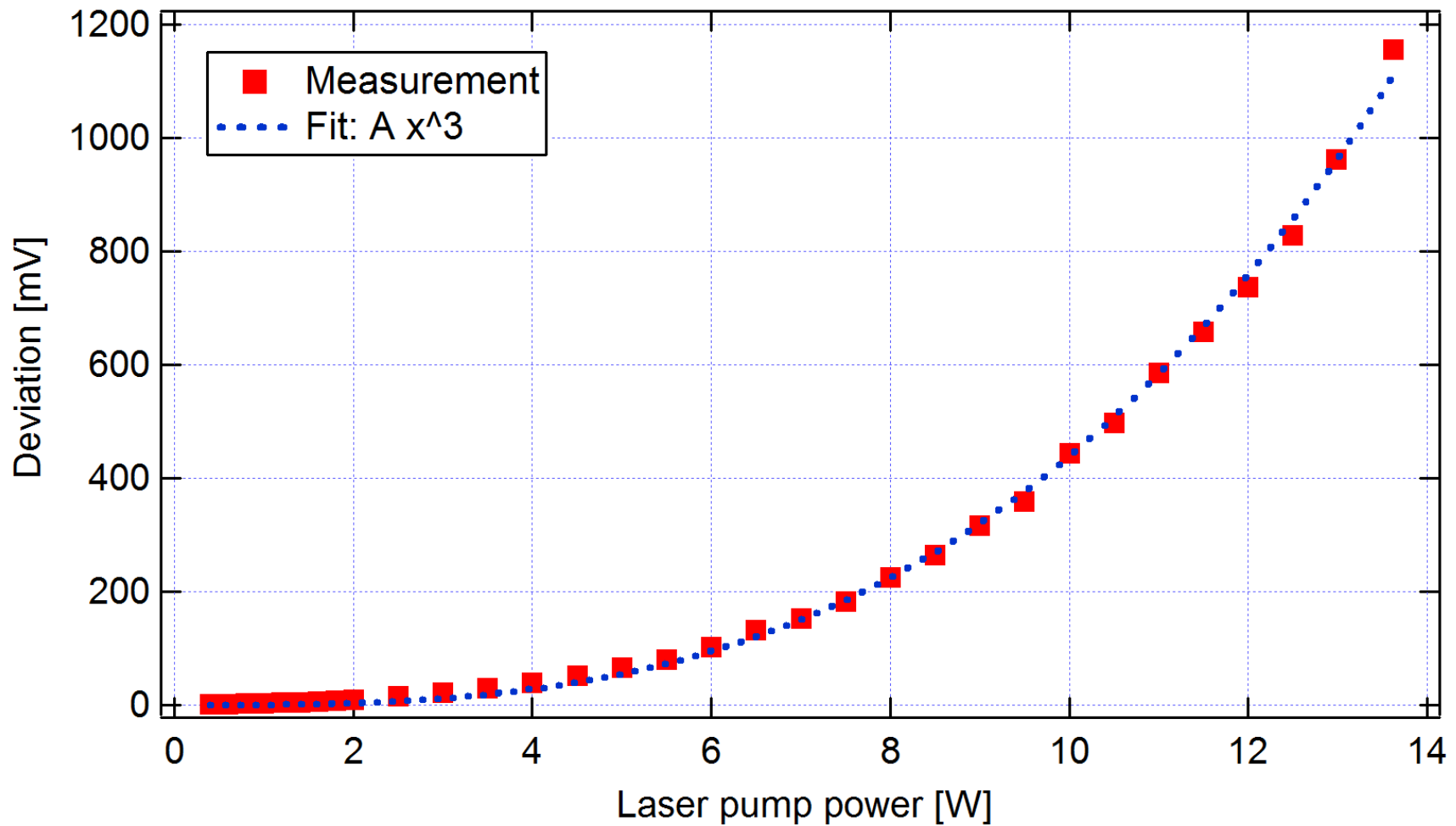

Absorption proportional to the square of the pump power ?

The simple absorption theory

Free Carrier Absorption (FCA): light absorbed by free carrier

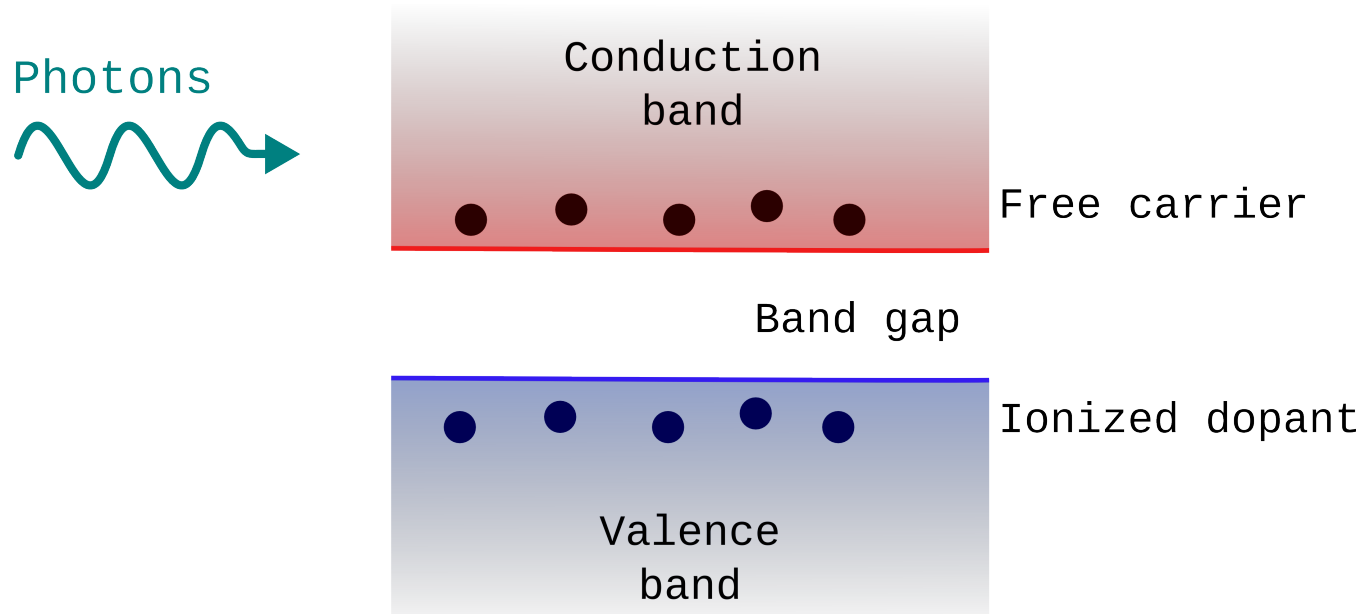

Resistivity \rightarrow Doping level \rightarrow Free carrier density \rightarrow Absorption

10 kOhm.cm $4 \times 10^{11} \text{ cm}^{-3}$ $4 \times 10^{11} \text{ cm}^{-3}$ 6 ppm/cm

\rightarrow Solid theory

\rightarrow Theory there but empirical relation¹

¹ Electrooptical effects in silicon, Soref and Bennett, IEEE Journal of Quantum Electronics, Vol 23, p123 (1987)

Non linearities in silicon ?

phys. stat. sol. (a) 203, No. 5, R38–R40 (2006) / DOI 10.1002/pssa.200622062



July 15, 2007 / Vol. 32, No. 14 / OPTICS LETTERS 2031

Impact of two-photon absorption on self-phase modulation in silicon waveguides

Lianghong Yin and Govind P. Agrawal

Institute of Optics, University of Rochester, Rochester, New York 14627, USA

Nonlinear absorption in silicon and the prospects of mid-infrared silicon Raman lasers

Varun Raghunathan, Ramesh Shori, Oscar M. Stafsudd, and Bahram Jalali

Influence of nonlinear absorption on Raman amplification in Silicon waveguides

R. Claps, V. Raghunathan, D. Dimitropoulos, and B. Jalali

Optical dispersion, two-photon absorption and self-phase modulation in silicon waveguides at 1.5 μ m wavelength

H. K. Tsang, C. S. Wong, T. K. Liang, I. E. Day, S. W. Roberts et al.

Citation: *Appl. Phys. Lett.* **80**, 416 (2002); doi: 10.1063/1.1435801

Nonlinear optical phenomena in silicon waveguides: Modeling and applications

Q. Lin,^{1,*} Oskar J. Painter,¹ and Govind P. Agrawal²

Role of free carriers from two-photon absorption in Raman amplification in silicon-on-insulator waveguides

T. K. Liang and H. K. Tsang

Citation: *Appl. Phys. Lett.* **84**, 2745 (2004); doi: 10.1063/1.1702133

nature
photonics

FOCUS | REVIEW ARTICLES
PUBLISHED ONLINE: 30 JULY 2010 | DOI: 10.1038/NPHOTON.2010.185

Nonlinear silicon photonics

J. Leuthold*, C. Koos and W. Freude

ISSN 1054-660X, *Laser Physics*, 2011, Vol. 21, No. 1, pp. 137–147.
© Pleiades Publishing, Ltd., 2011.
Original Text © Astro, Ltd., 2011.

INTERACTION OF LASER
RADIATION WITH MATTER

Nonlinear Change in Refractive Index and Transmission Coefficient of Silicon at Long-Pulse, mJ-Range, 1.54- μ m Excitation¹

APPLIED PHYSICS LETTERS

VOLUME 82, NUMBER 18

Third-order nonlinearities in silicon at telecom wavelengths

M. Dinu,^{a)} F. Quochi, and H. Garcia

Bell Laboratories, Lucent Technologies, 101 Crawfords Corner Road, Holmdel, New Jersey 07733

IOP PUBLISHING

JOURNAL OF PHY

J. Phys. D: Appl. Phys. **40** (2007) R249–R271

doi:10.108

TOPICAL REVIEW

Ultrafast nonlinear all-optical processing in silicon-on-insulator waveguides

R Dekker¹, N Usechak², M Först³ and A Driessen¹

The steady state (simplified) theory I

Two Photon Absorption (TPA):

Two photons are absorbed to create a electron-hole pair:

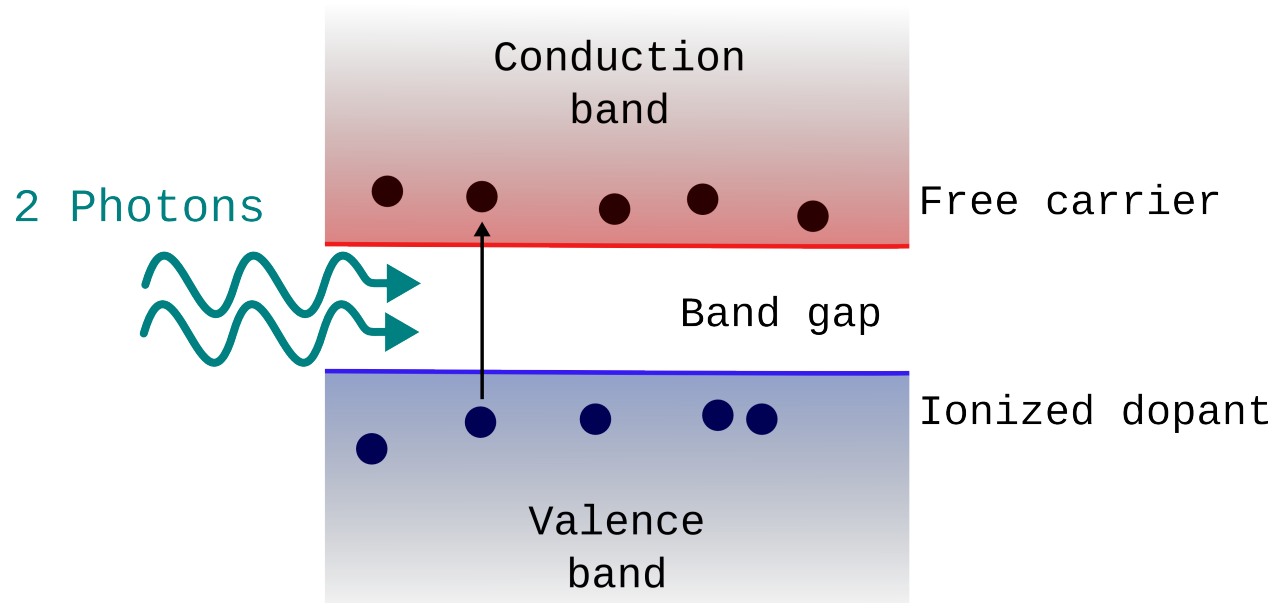

Power absorbed:

$$\frac{dI}{dz} = -\beta I^2$$

$$\alpha_{TPA} = 3 \left(\frac{P_{laser}}{10W} \right)^2 \text{ ppm/cm}$$

β : TPA coefficient

0.8 cm/GW at 1550 nm

I : Laser intensity

70 MW/m² for 10W

The steady state (simplified) theory II

When 2 photons are absorbed, creation of a electron-hole pair
 N_e and N_h = density of free electron and hole.

Evolution of free carrier density:

$$\frac{dN_{e,h}}{dt} = \frac{\beta}{2h\nu} I^2 - \frac{N_{e,h}}{\tau}$$

τ : free carrier lifetime
 ~ 1 ns

At the equilibrium:

$$N_{e,h} = \frac{\beta\tau}{2h\nu} I^2$$

$$N_e, N_h \sim 1.6 \times 10^{14} \text{ /cm}^3$$

And the absorption is given by:

$$\alpha_{FCA} = (8.5N_e + 6.0N_h) \times 10^{-18} \text{ ppm/cm} \quad \alpha_{TPA} \sim 2300 \text{ ppm/cm}$$

Absorption proportional to the square of the laser power!

Other non linear effect

We are not directly measuring the absorption but the gradient of refractive index

Other sources of deviation:

- Free Carrier Dispersion (FCD):
the refractive index depends of the free carrier density:

$$\Delta n = -(8.0N_e + 5.4N_h) \times 10^{-22}$$

- Kerr effect:
refractive index directly proportional to the laser power

$$\Delta n = C_{Kerr} P_{laser} \quad C_{Kerr} = 4 \times 10^{-14} \text{ cm}^2/\text{W}$$

(negligible effect, except at very low temperature)

Summary for silica and sapphire

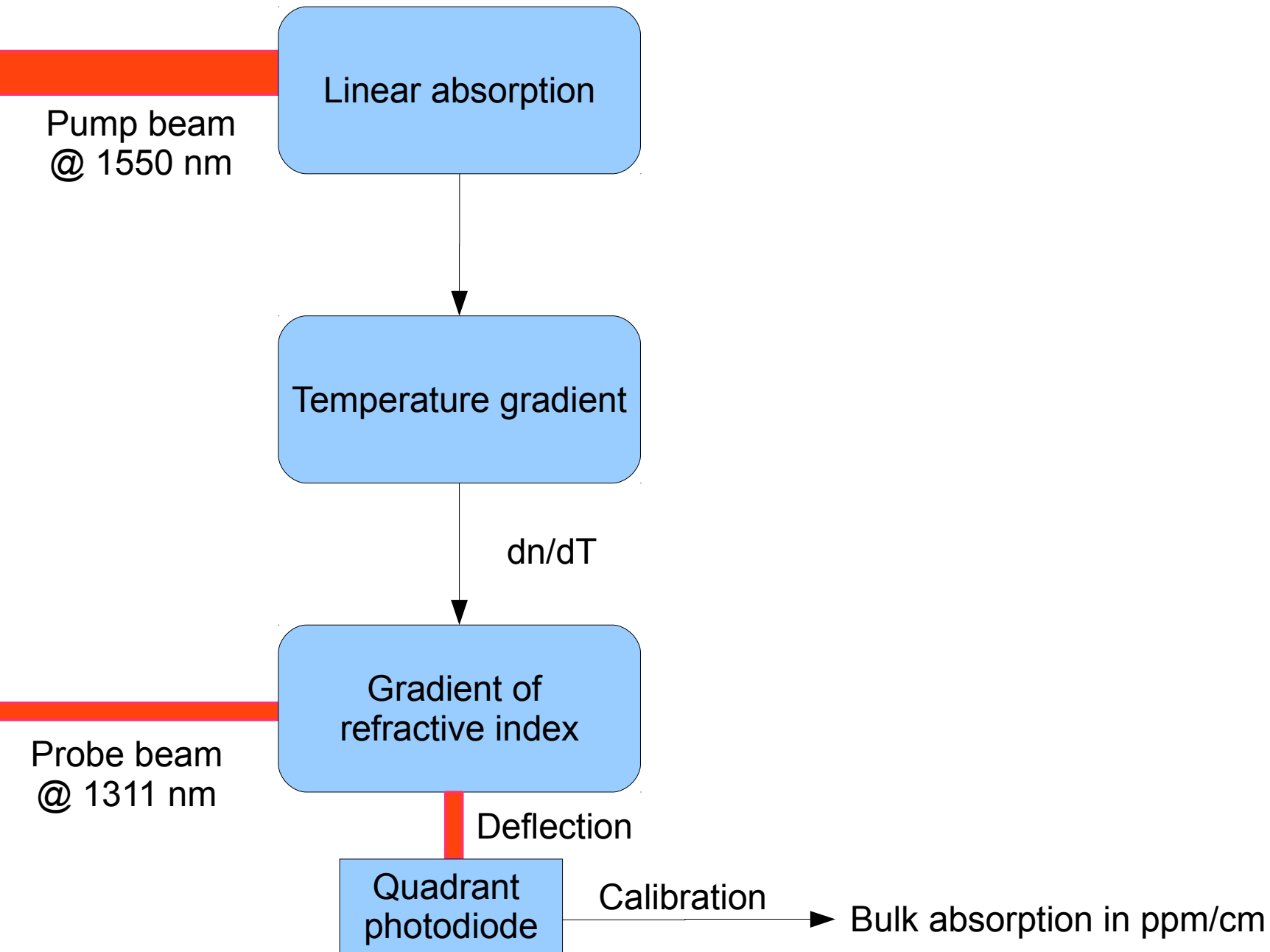

Summary for silicon

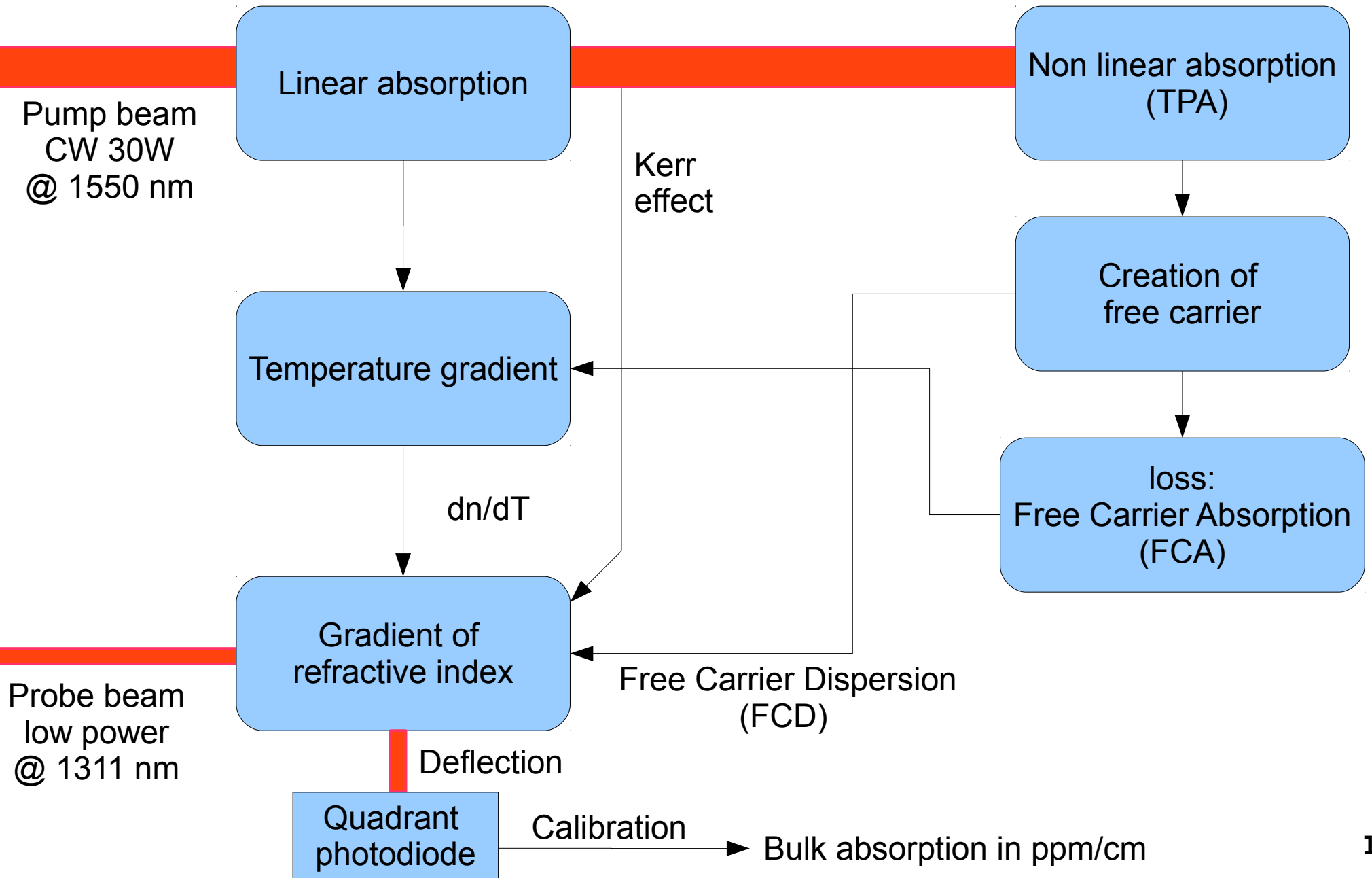

Evolution of the free carrier density

More complicated than the previous calculation because of the free carrier diffusion
(electrons do not stay where they are created)

$$\frac{\partial N_{e,h}(r, t)}{\partial t} = D_{e,h} \nabla^2 N_{e,h}(r, t) - \frac{N_{e,h}(r, t)}{\tau} + A(t) \exp\left(-2 \frac{r^2}{w^2}\right)$$

Evolution
term

Diffusion
term

Recombination
term

Source term
(TPA)

$$D_e = 36 \text{ cm}^2 / \text{s}$$

$$D_h = 12 \text{ cm}^2 / \text{s}$$

Model solved numerically for simple case: harmonic excitation or step function

Essential to derive the absorption in silicon

Evolution of the free carrier density

Steady state concentration With Gaussian illumination

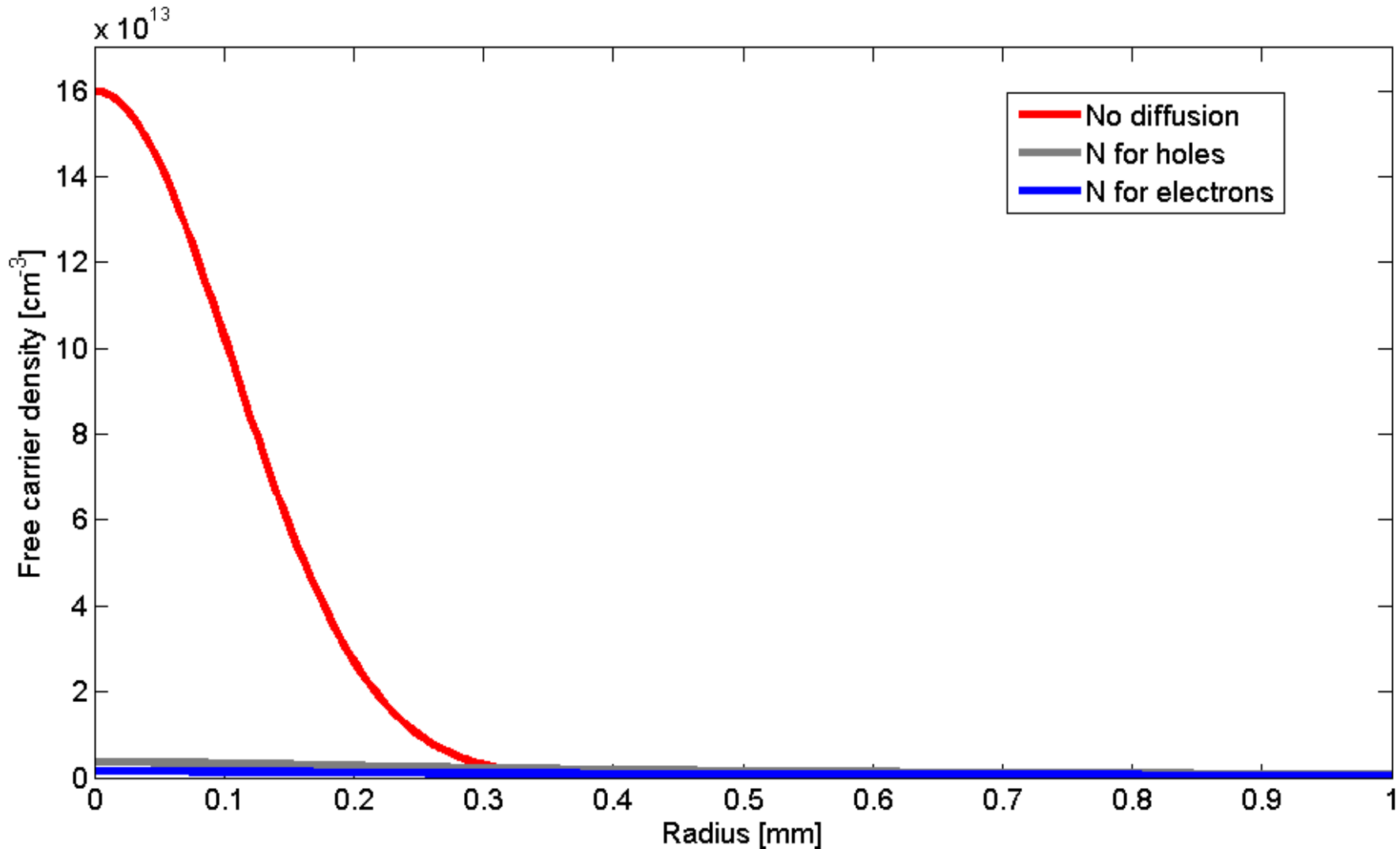

Evolution of the free carrier density

More complicated situation:

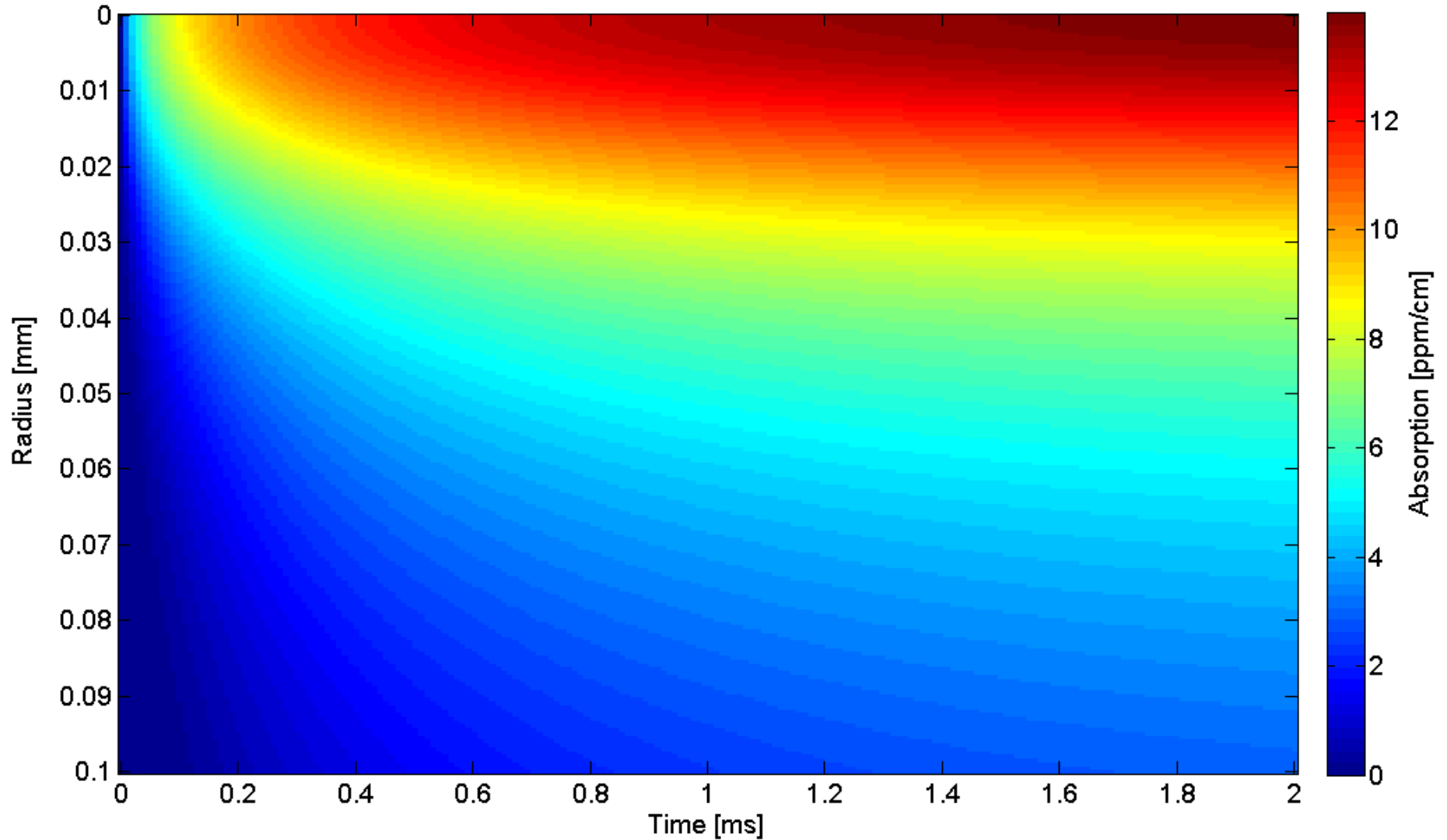

Absorption depends on space and time!

Back to the measurement

Can we see the absorption changing ?

Record directly the raw deviation illuminated by a square wave

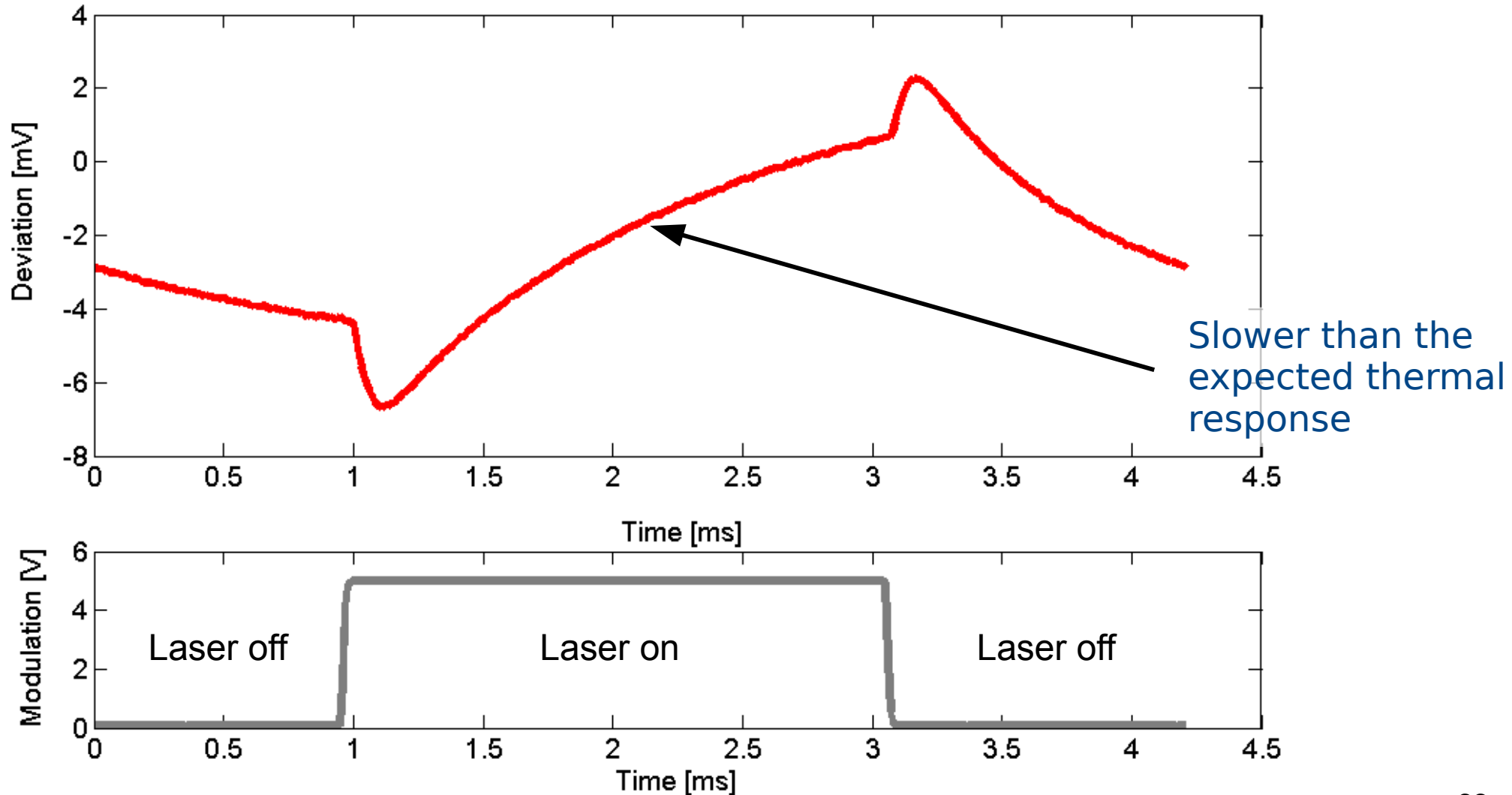

A closer look to the response

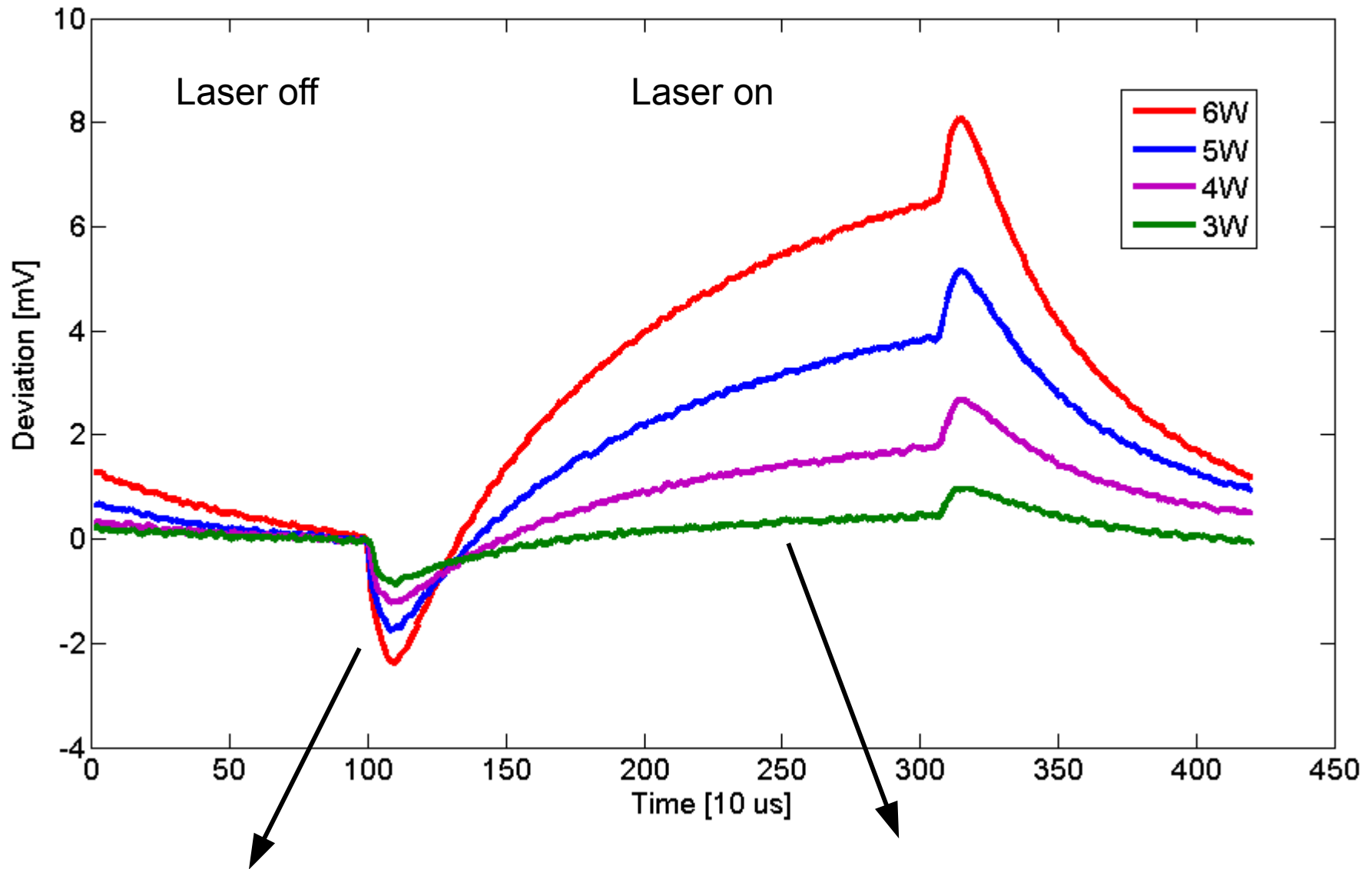

Change of the refractive index in response to the change in free carrier density(FCD). Proportional to the gradient of free carrier

Thermal response from the change of absorption. Proportional to the amount of free carrier

Why did the simulation say ?

Response of the deviation to a step function
Evolution over 0.2 ms

Experiment

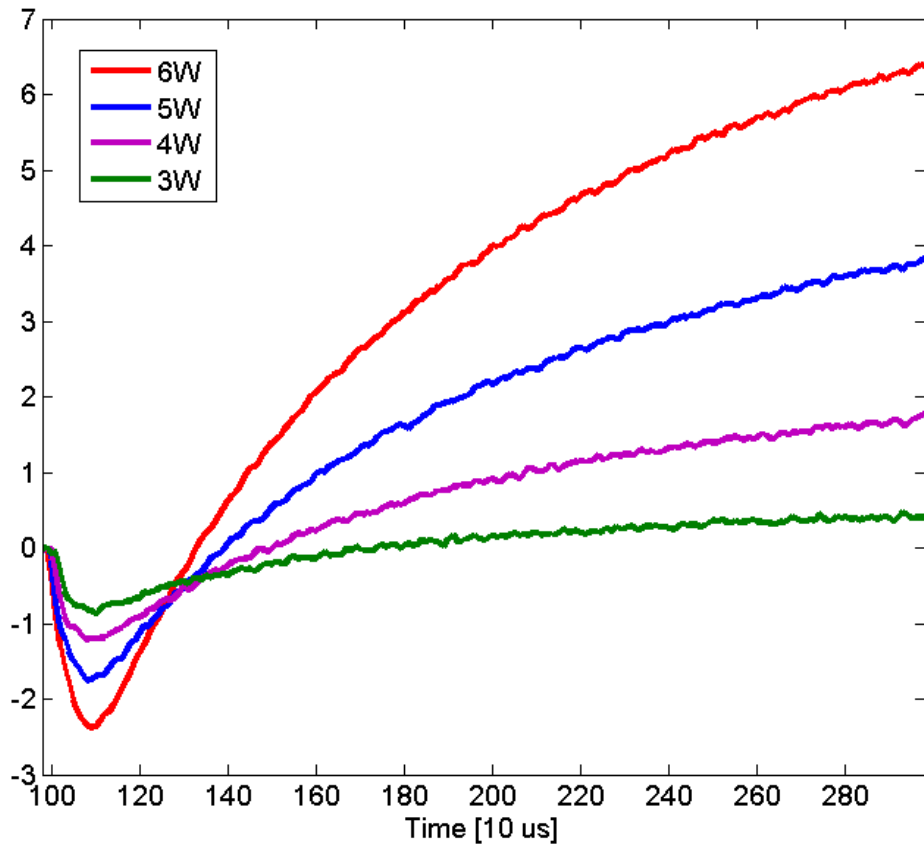

Theory

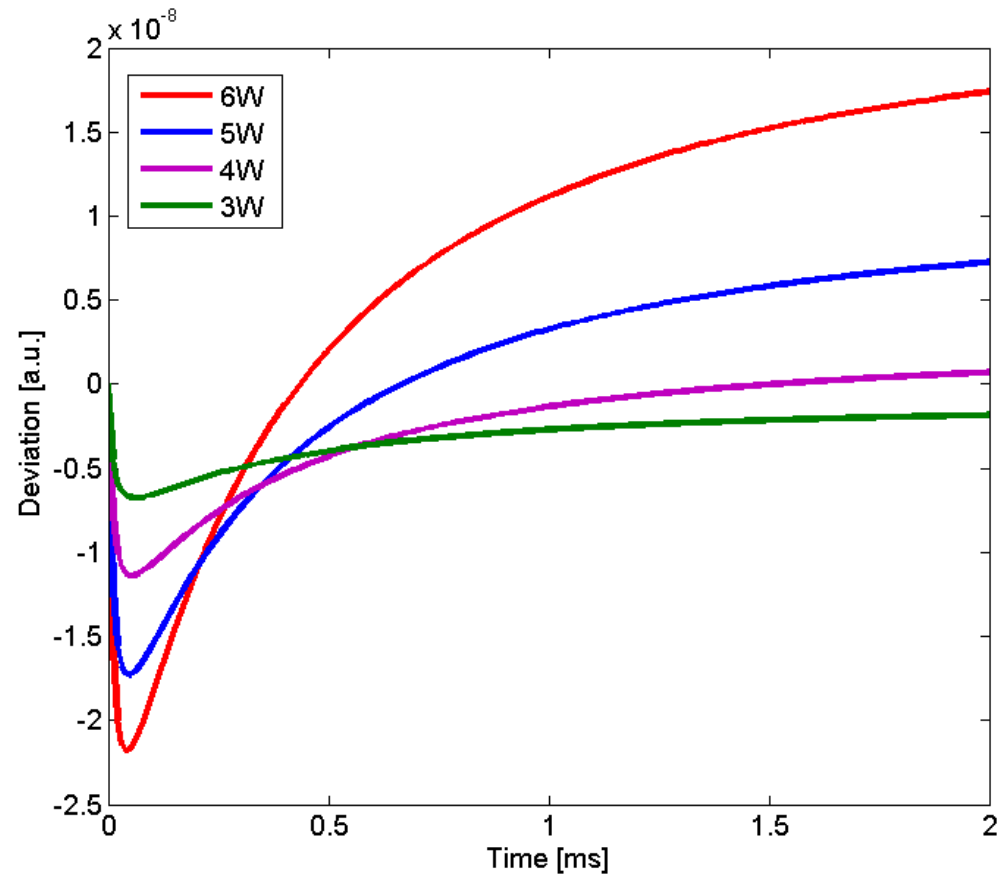

Comparison of 2 different samples

higher resistivity sample shows higher deviation!

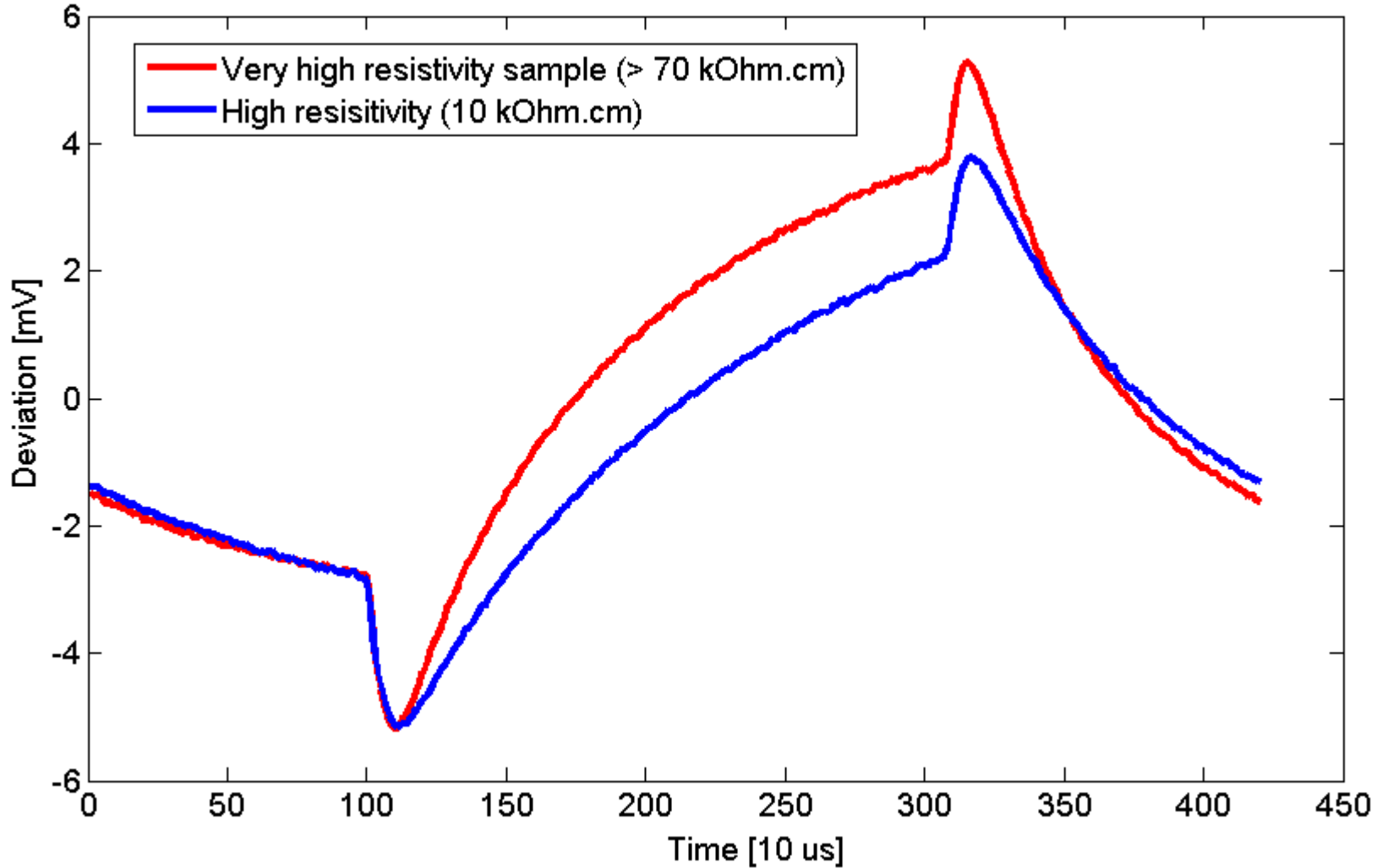

High resistivity → high purity → long free carrier lifetime

High density of free carrier (they accumulate) → higher absorption

And with calibrated data

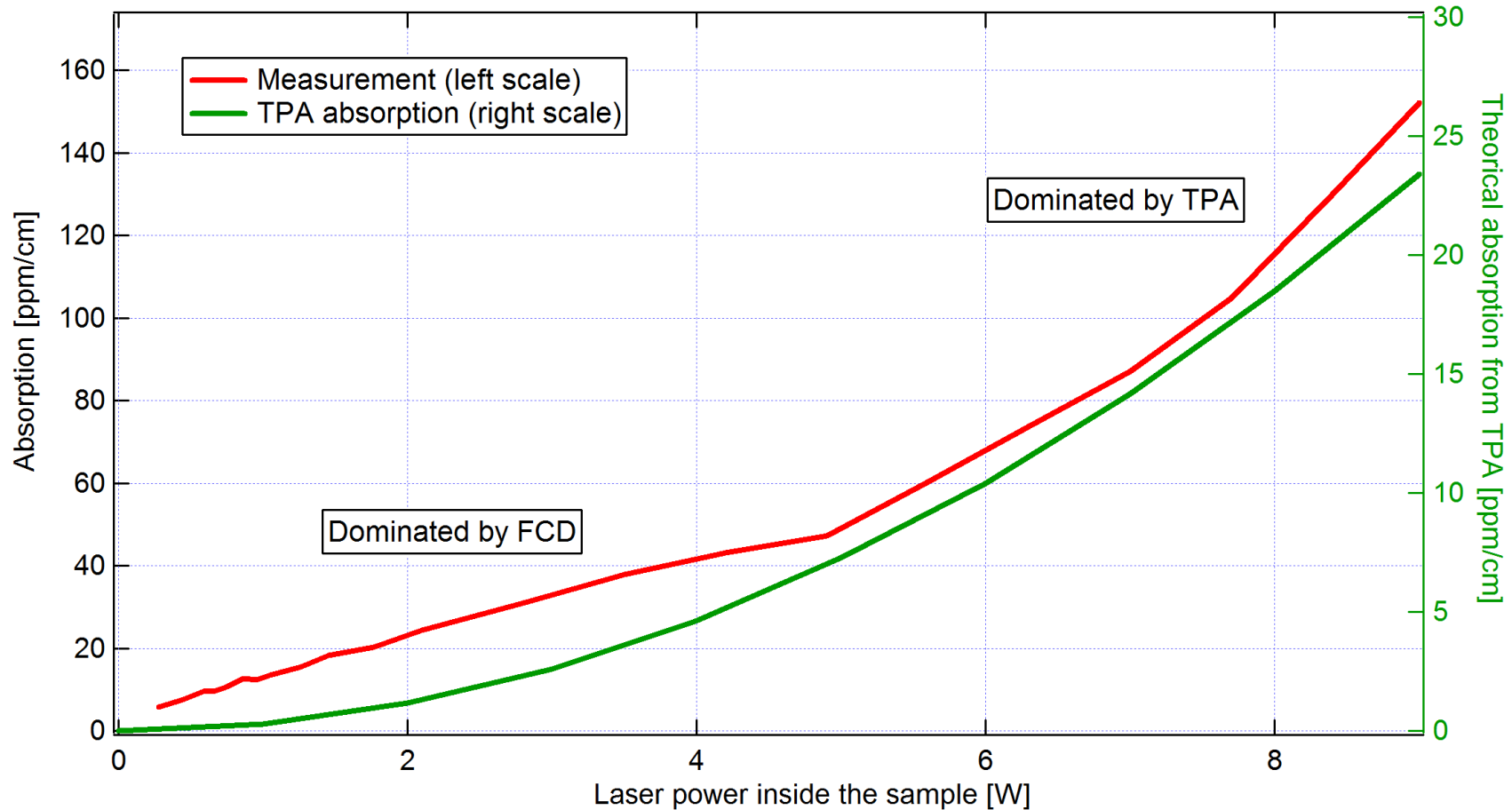

- Even at low power dominated by non linear effect (absorption power dependent)
- Absorption less than 10 ppm/cm
- At high power, absorption 6 times higher than expected from the theory → checking the reference in absorption and the theory.

What about ET ?



Main tests done are done at room temperature with a small beam.

For ET, large beam (9 cm) and low power (30W). Very low laser intensity.

Non linear effects become negligible.

(example: two photon absorption = 10^{-4} ppm/cm)

What about the (intensity independent) free carrier concentration from the dopant ?

Free carrier freeze out ?

No ionised dopant (so no free carrier) or not ?

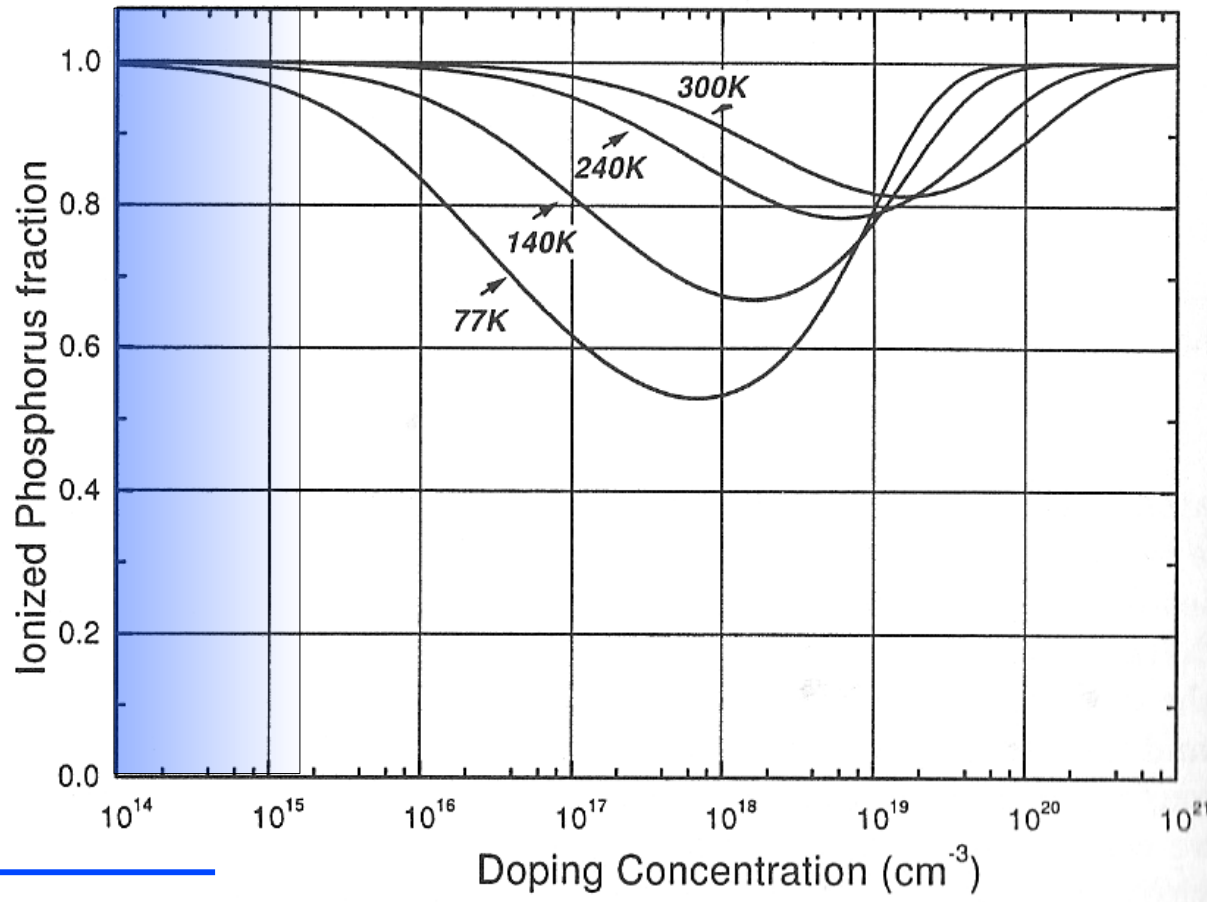

←
Desired doping

Even at low temperature, all the dopant may be ionised

What substrate absorption is desirable ?

From ET design study:

$$P_{\text{PRC}} = 65 \text{ W}$$

$$P_{\text{arm}} = 18 \text{ kW}$$

Thickness mirror = 50 cm

If we suppose the current lowest coating absorption: 0.3 ppm,
we get 5 mW absorbed in the coating.

To have the same amount absorbed in the substrate: absorption
substrate $\sim 2 \text{ ppm/cm}$

(if all dopand ionized, resisitivity $\sim 30 \text{ kOhm.cm}$)

Comparison with Kagra¹:

1 W absorbed by the coating and substrate

200 mW due to the radiation from hotter part

¹ Detector configuration of KAGRA—the Japanese cryogenic gravitational-wave detector, K. Somiya, Classical and Quantum Gravity, Vol 29, p124007 (2012)

Improved cryogenic setup

- Some evidence of diffused light reaching the temperature sensor
- Pump power at 940 nm leaking from the 1550 nm laser

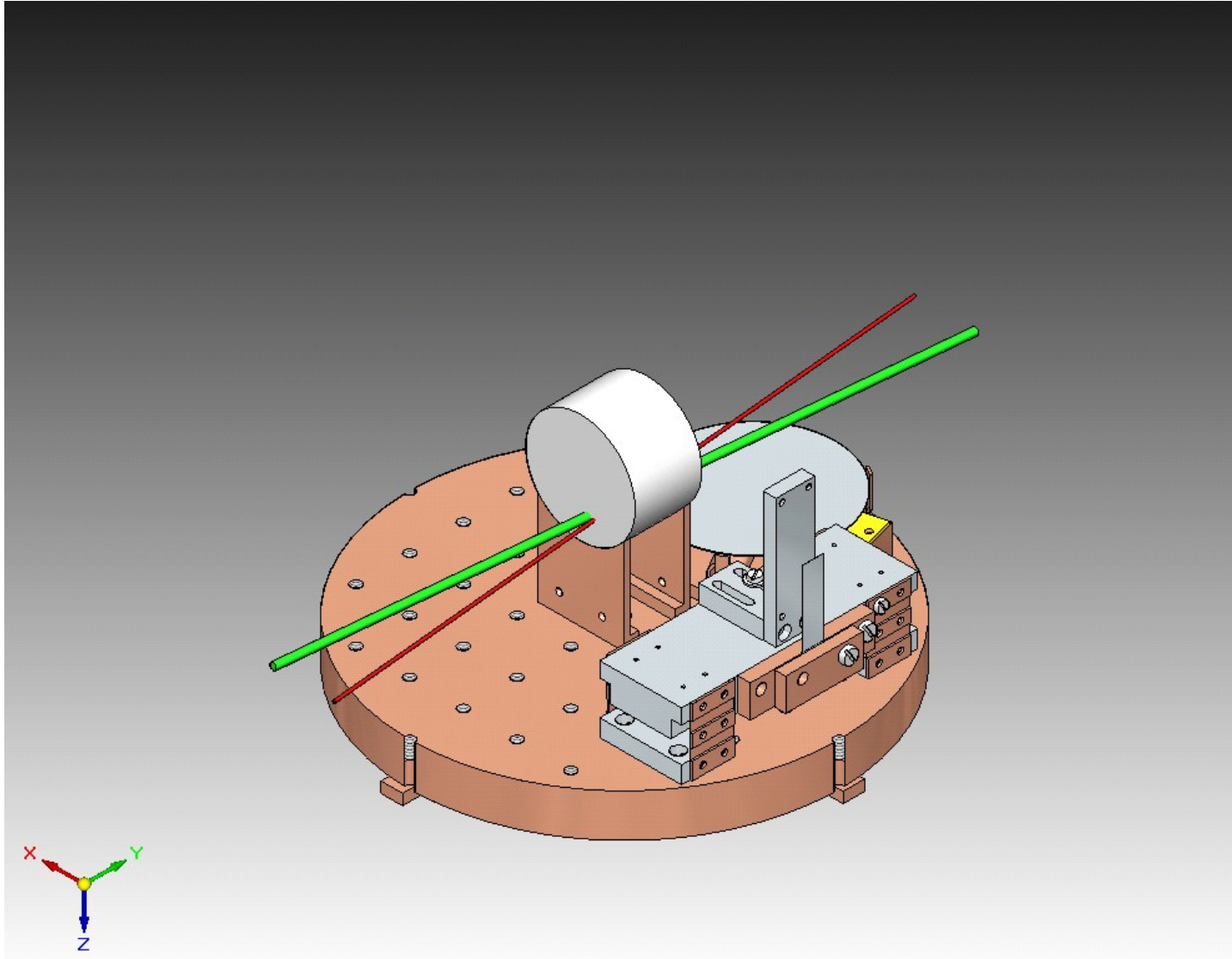

Improved cryogenic setup

- Some evidence of diffused light reaching the temperature sensor
- Pump power at 940 nm leaking from the 1550 nm laser

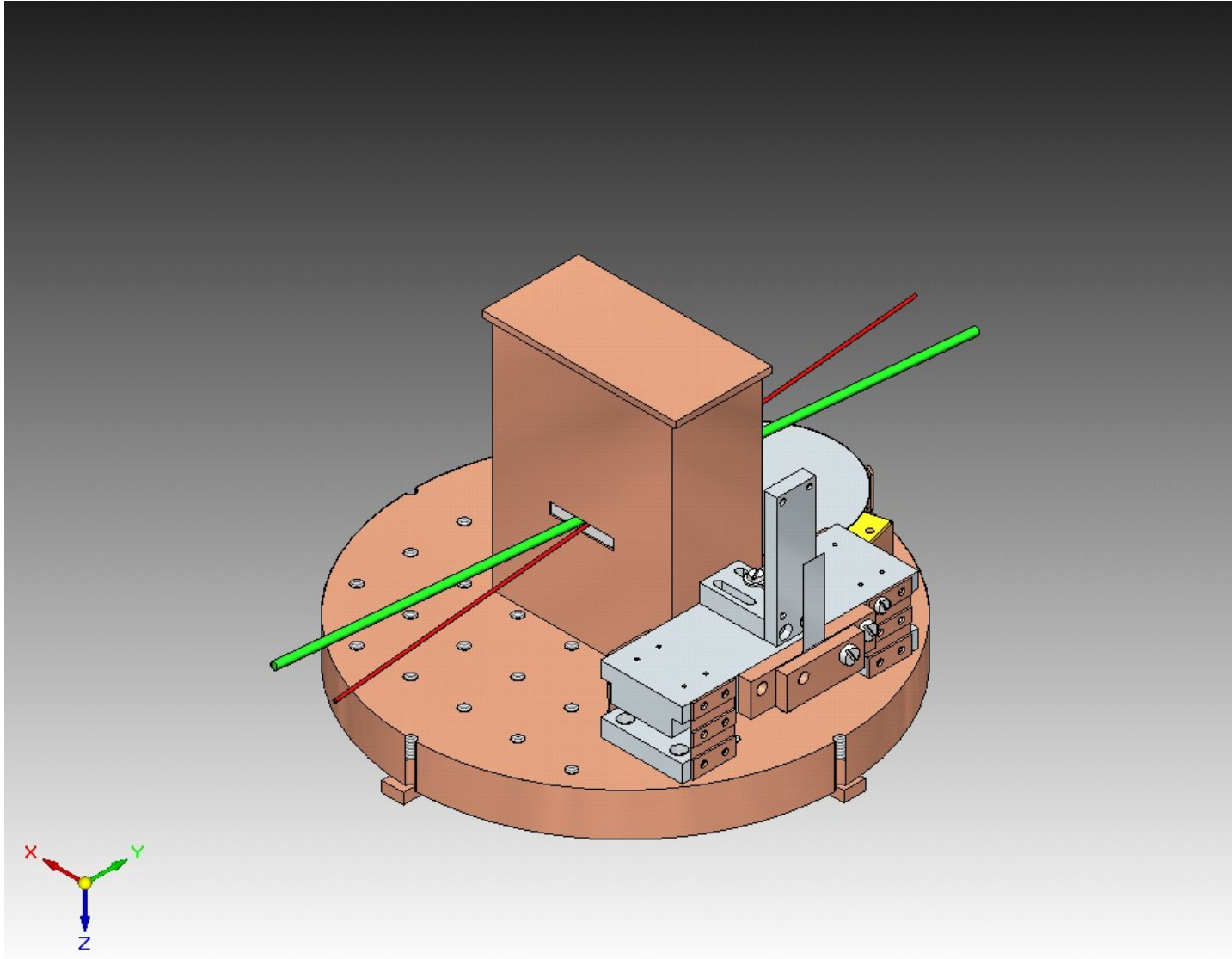

Conclusion



At room temperature

- Non linear effect clearly visible even at low power
- Effect qualitatively well understood
- Lowest absorption measured: <10 ppm/cm but checking the calibration

With ET parameters

- Non linear effects not an issue
- Would be good to derive the maximum acceptable absorption
- Currently improving our cryogenic setup